

ALWAYS
THE BEST
**PROTECTION
PROFILES**



OCTOBER 2017



 **mpm**
PLASTIC PROFILES

PRESENTS NEW MATERIAL

 **REFLEX**
RESISTANT AND FLEXIBLE





CONTENTS



page 02

01	Rack Protector	page 06	05	Corner Protection	page 38
02	Bollard	page 08	06	Wall Protection	page 40
03	Guard Rail	page 12	07	Antishock System	page 44
04	Kerb	page 34	08	PVC Panel	page 46

OUR PENDULUM MACHINE FOR CRASH REPORTS



WE HAVE RECENTLY PASSED **IMPACT TEST** ON THESE PRODUCTS
THANKS TO THE NEW REFLEX MATERIAL



RACK PROTECTORS

ACCORDING TO DIN EN 15512:2010-09

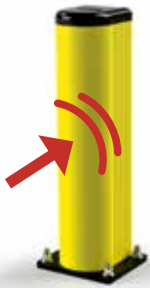

BOLLARD GRD 150

ACCORDING TO DGUV Regel 108-007

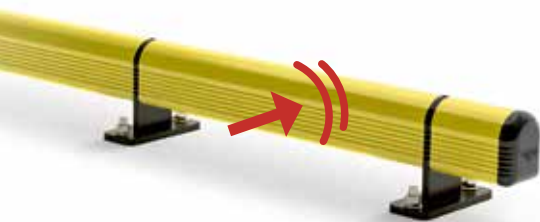

CONTINUOUS GUARD RAIL GRIN 150

ACCORDING TO AFNORNP P98-310

... AND WE ARE STILL WORKING TO IMPROVE QUALITY OF OUR PRODUCTS ...

WHY PVC PROTECTIONS ARE **THE BEST CHOICE** IN COMPARISON TO METAL OR OTHER MATERIALS

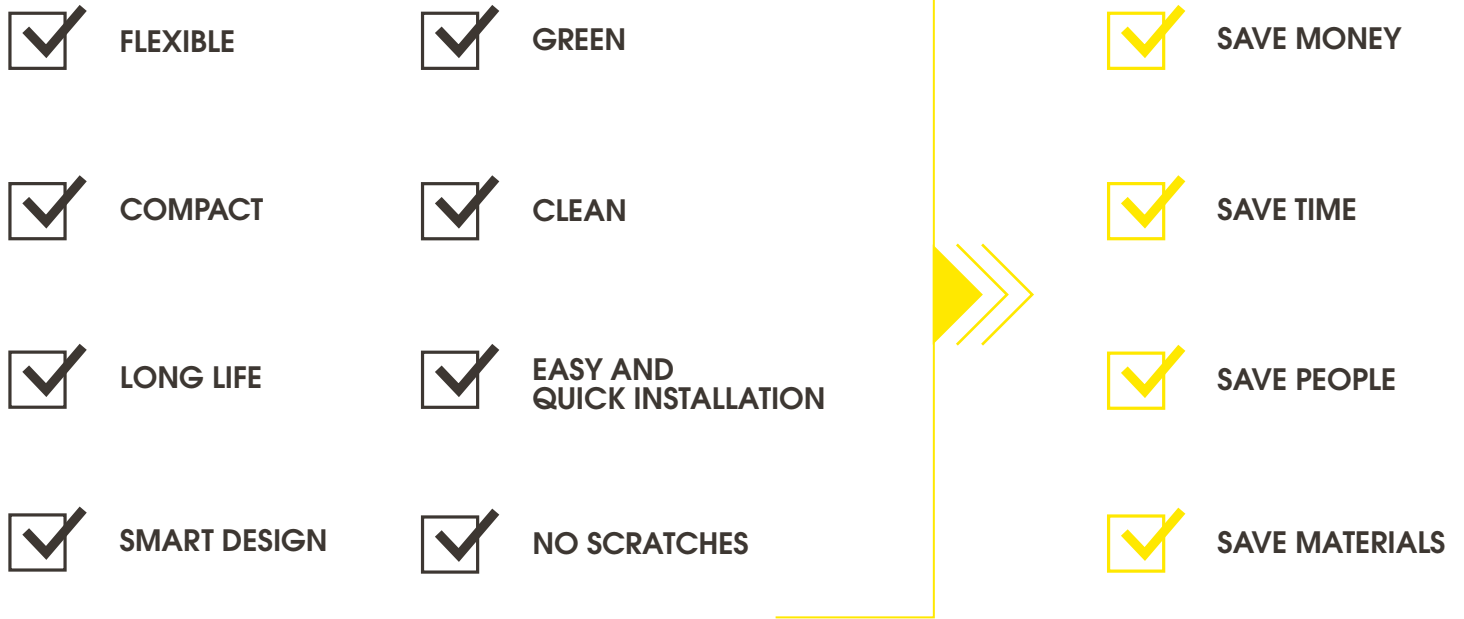

RESEARCH AND DEVELOPMENT

CUSTOMISED PROJECT MANAGEMENT SERVICE



01

RACK PROTECTOR



**HIGH
IMPACT
ABSORPTION**

Full range of pvc profiles for protection of warehouse racks.

Gamma completa di profili in pvc per la protezioni di scaffali.

Complète gamme de profilés en PVC pour la protection de d'égagères de dépôts.

**OUR PROFILES
FIT ALL RACKS**



EASY TO INSTALL

THE ONLY ONE WITH TRIPLE SHOCK ABSORBER

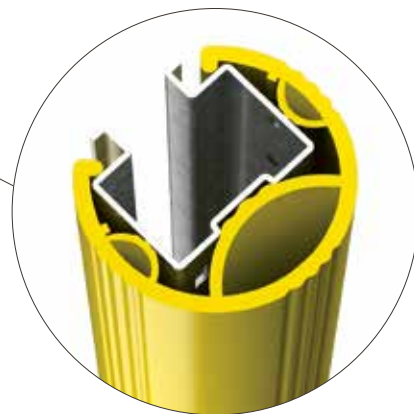

RPS 600

60 80

ANTISHOCK MATERIAL INSIDE

Packing 6 pz / box
Packing 114 pz / big parcel
Colour M

Available also size 400

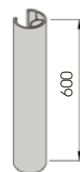

RPM 600

80 100

ANTISHOCK MATERIAL INSIDE

Packing 4 pz / box
Packing 80 pz / big parcel
Colour M

Available also size 400

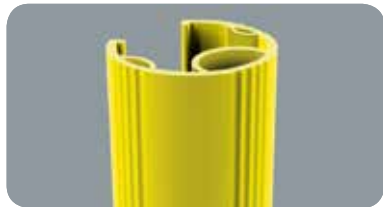
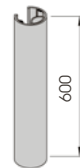

RPL 600

100 120

ANTISHOCK MATERIAL INSIDE

Packing 2 pz / box
Packing 54 pz / big parcel
Colour M

Available also size 400

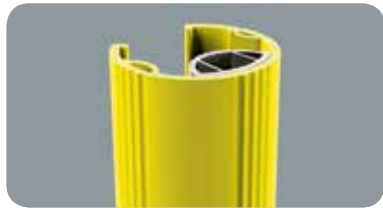

RPXL 600

100 120

ANTISHOCK MATERIAL INSIDE

Packing to be defined
Colour M

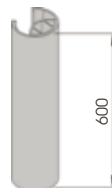

RP CLICK

Packing 1 pz / box

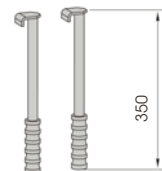

RPF 600

Equipped with accessories

FLEXIBLE

Packing 2 pz / bag
Colour C

60 130

Axle spacing 25 - 50 - 75 mm

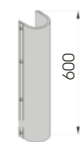

02

BOLLARD

In addition to guard rail system, please check page 8
A completamento della linea guard rail, vedi pag. 8
Pour compléter la gamme guard rail, voir la page 8



Designed to protect access to gates or big doors from huge traffic or simply to mark restricted areas for pedestrians. Fully equipped with fixing accessories.

Ideato per proteggere l'accesso a cancelli o portoni dalla movimentazione di mezzi pesanti o semplicemente per impedire l'ingresso di pedoni. Provvisto di accessori di fissaggio.

Etudié pour protéger l'accès aux portes ou entrées de grand trafic ou simplement pour marquer les zones de passage piétons. Equipé avec les accessoires d'installation.



ROD



RE
EASY TO
REMOVE AND
TO REPLACE



GALVANISED STEEL

Fixing accessory available also in stainless steel



ROD PE 70 266 RE
Equipped with accessories
Drill \varnothing 38

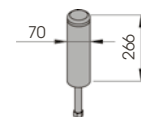

Packing
Colour **6 pz / box**

ROD PE 120 433 RE
560 RE
Equipped with accessories
Drill \varnothing 56



Packing
Colour **1 pz / bag**

GRD

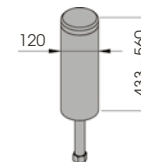

FAST
AND EASY
TO INSTALL



**M12
GALVANISED STEEL**



GRD 90 250
Equipped with accessories



Packing **unpacked on pallet**
Colour **B M**

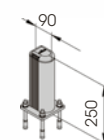

**GRD 150 500
800
1100**
Equipped with accessories



Packing **unpacked on pallet**
Colour **B M**

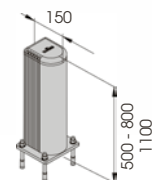

03

GUARD RAIL

A new bumper system specific for the protection of the walls resistant against trolleys movements. Designed by following an innovative technical design that combines speed and simplicity in the steps of installation and cleaning. Available in different lengths.

Sistema profili antiurto specifico per la protezione delle pareti dai carrelli in movimento. Progettato seguendo un innovativo disegno tecnico che coniuga rapidità e semplicità nelle fasi di installazione e pulizia. Disponibile in diverse lunghezze.

Nouveau système bumper, spécifique pour protéger les murs contre les mouvements des charriots. Étudié avec un modern dessin qui regroupe la rapidité et la facilité pendant l'installation et le nettoyage. Disponible en différents longueurs.





Guard Rail

GUARD RAIL 90



QUICK
INSTALLATION
WITH
EXPANSION
SCREW



M16
GALVANISED STEEL



ALTERNATIVE FIXING
HIGH RESISTANCE WITH RESIN



M16
STAINLESS STEEL



GR 90 500
750
1000
1500

Equipped with accessories

Length 500 mm
Packing 4 pz / box

Length 750 / 1000 / 1500 mm
Packing 2 pz / box

Colour B M

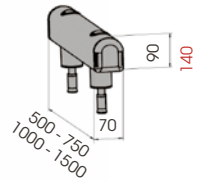

GR 90 2000
3000
4000

Equipped with accessories

Length 2.000 / 3.000 / 4.000 mm
Packing 2 pz / box
Colour B M

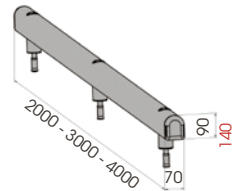

GUARD RAIL 150



**M20
STAINLESS STEEL**

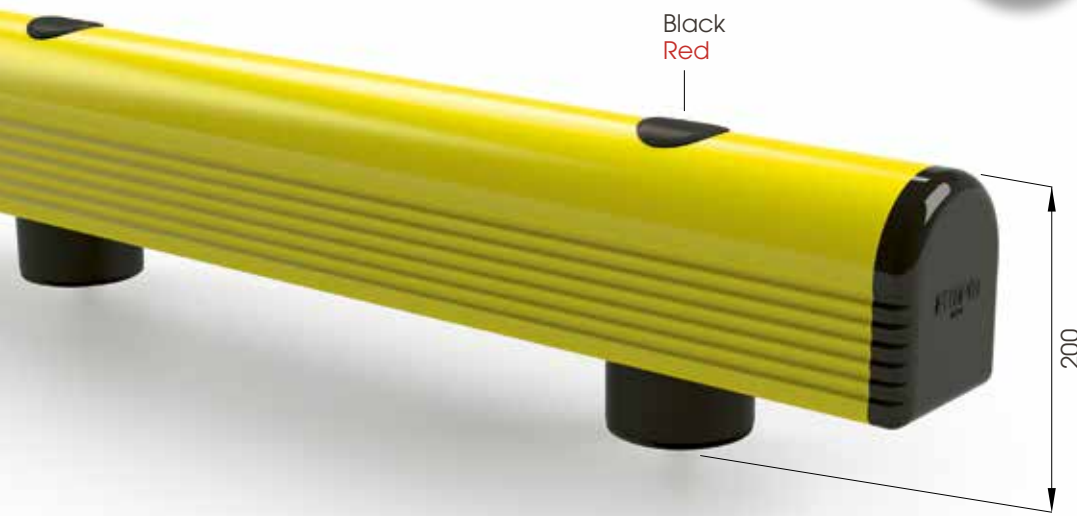

GR 150 500
750
1000
1500

Equipped with accessories

Length 500 / 750 / 1000 / 1500 mm
Packing unpacked on pallet
Colour B M

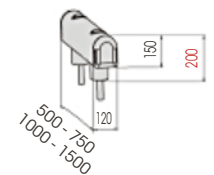

GR 150 2000
3000
4000

Equipped with accessories

Length 2.000 / 3.000 / 4.000 mm
Packing unpacked on pallet
Colour B M

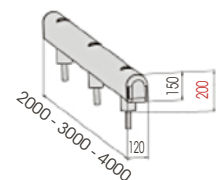

Guard Rail

GRIN 90



GRINCO 90

M12 GALVANISED STEEL



GRIN 90 1500

Length **1500 mm**
 Packing **to be defined**
 Colour **M**



GRINCO 90
 Equipped with accessories

Packing **to be defined**
 Colour **M**

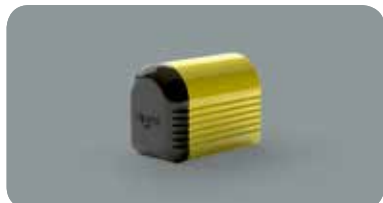
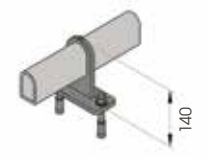

GRINT 90
 Equipped with accessories

Packing **to be defined**
 Colour **M**

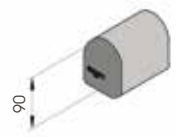

GRIN 150



HIGH RESISTANCE PERFORMANCE

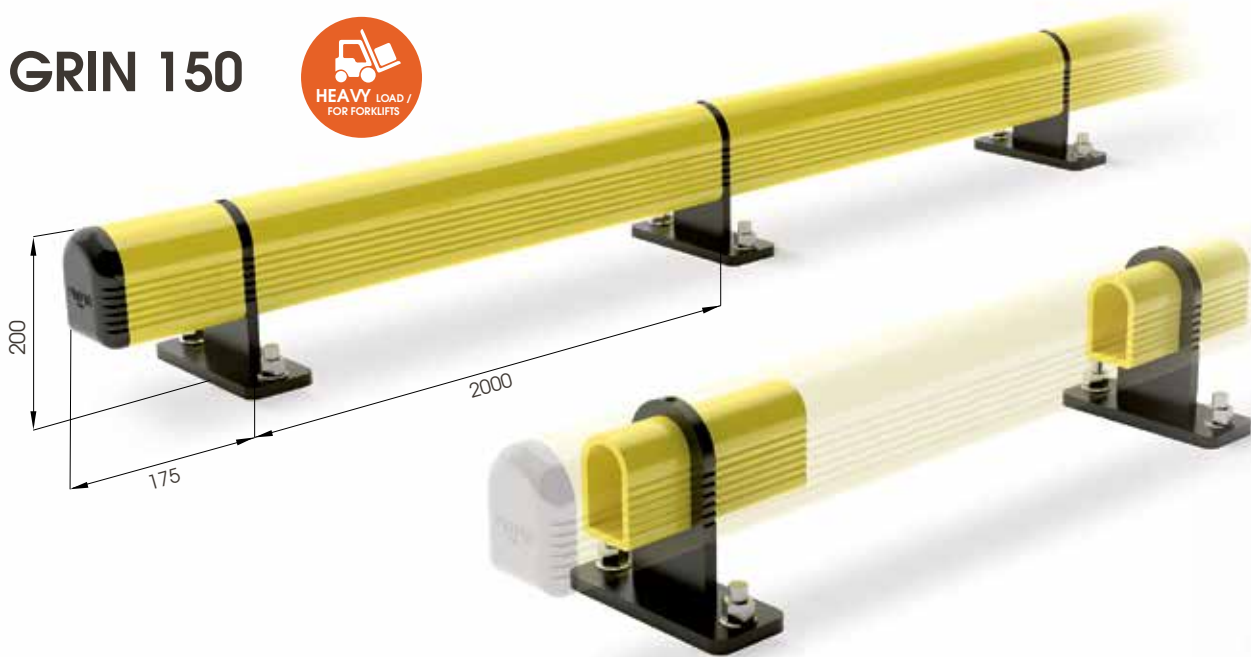

GRINCO 150

M12 GALVANISED STEEL



GRIN 150 2000

Length **2000 mm**
Packing **to be defined**
Colour **M**

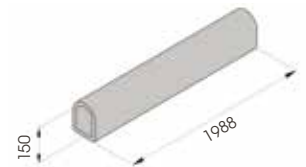

GRINCO 150

Equipped with accessories

Packing **to be defined**
Colour **M**

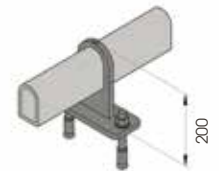

GRINT 150

Equipped with accessories

Packing **to be defined**
Colour **M**

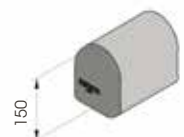

Guard Rail

SM



DIFFERENT SIZES ON REQUEST

FAST AND EASY TO INSTALL



M12 GALVANISED STEEL



SM 1500x400 MODULAR
Equipped with accessories

Packing Colour **unpacked on pallet**
B M

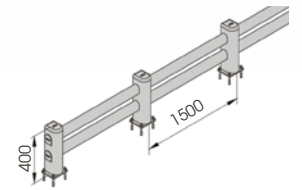

SM 1100x400
Equipped with accessories

Length Packing Colour **unpacked on pallet**
B M

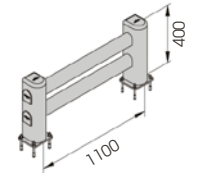

LM



DIFFERENT SIZES ON REQUEST

FAST AND EASY TO INSTALL

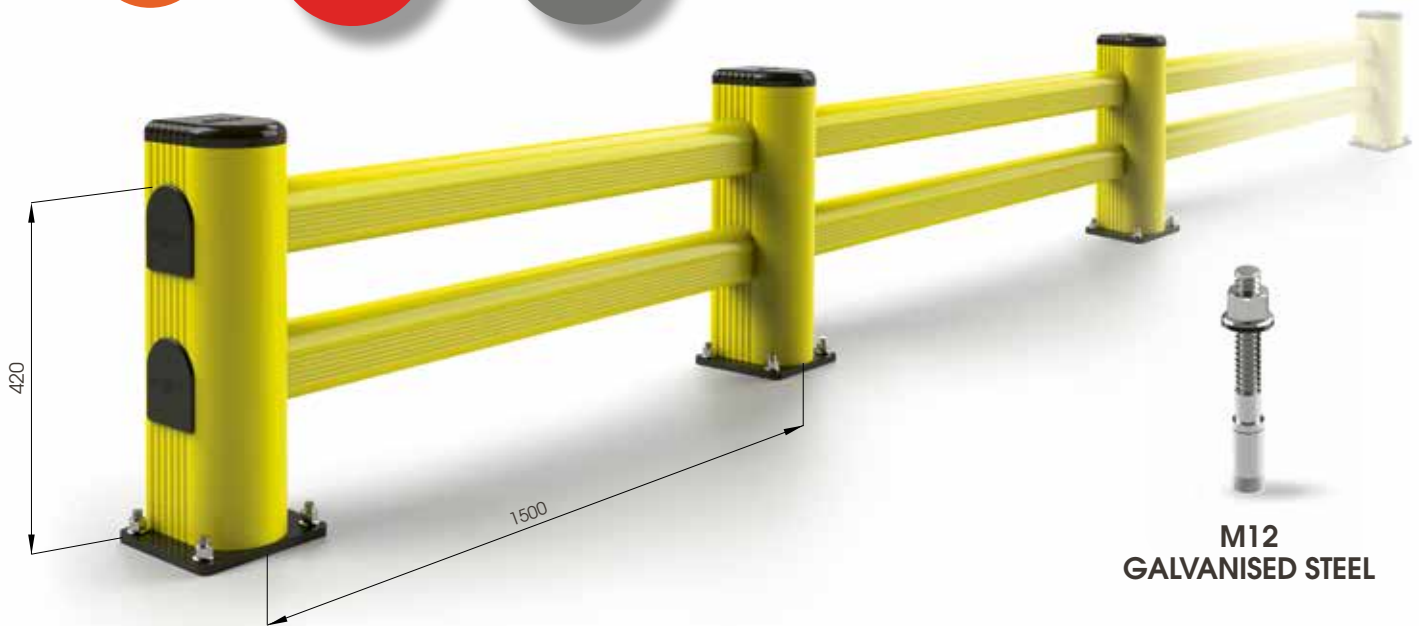

M12 GALVANISED STEEL



LM 1500x500 MODULAR
Equipped with accessories

Packing **unpacked on pallet**
Colour **B M**

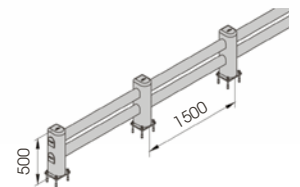

**LM 1100x500
2400x500**
Equipped with accessories

Length **1.100 / 2.400 mm**
Packing **unpacked on pallet**
Colour **B M**

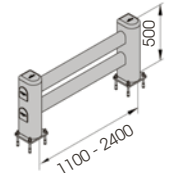

Guard Rail

FENCE 90



DIFFERENT SIZES ON REQUEST

FAST AND EASY TO INSTALL



M12 GALVANISED STEEL



FE 90 1100x350
Equipped with accessories

Length **1.100 mm**
Packing **unpacked on pallet**
Colour **B M**

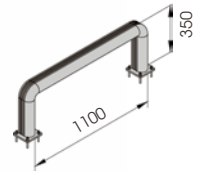

FE 90 2400x350
Equipped with accessories

Length **2.400 mm**
Packing **unpacked on pallet**
Colour **B M**



FENCE 150



DIFFERENT SIZES ON REQUEST

FAST AND EASY TO INSTALL



M12 GALVANISED STEEL



FE 150 1100x550
Equipped with accessories

Length **1.100 mm**
Packing **unpacked on pallet**
Colour **B M**



FE 150 2400x550
Equipped with accessories

Length **2.400 mm**
Packing **unpacked on pallet**
Colour **B M**



FENCE 150 REINFORCED



DIFFERENT SIZES ON REQUEST

FAST AND EASY TO INSTALL



M12 GALVANISED STEEL



FE 150 REF 1100x500

Equipped with accessories

Length Packing 1.100 mm
unpacked on pallet
Colour B M



FE 150 2400x500

Equipped with accessories

Length Packing 2.400 mm
unpacked on pallet
Colour B M



HAND RAIL 90



FAST AND EASY TO INSTALL



M12 GALVANISED STEEL



HR 90 1500x1150 MODULAR
Equipped with accessories

Packing Colour **unpacked on pallet**
Colour **M**

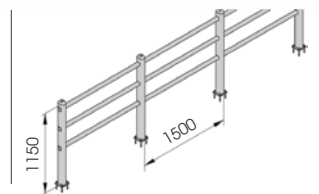

Guard Rail

PEDESTRIAN 90



FAST AND EASY TO INSTALL



M12 GALVANISED STEEL



PED 90 1500x1150 MODULAR

Equipped with accessories

Packing Colour **unpacked on pallet**

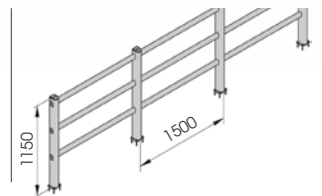

PEDESTRIAN 150



FAST AND EASY TO INSTALL



PED 150 1500x1150 MODULAR
Equipped with accessories

Packing Colour **unpacked on pallet**
Colour **B M**

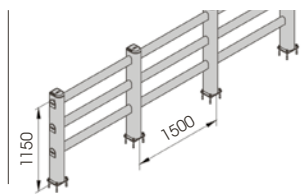

CORNER PED 150



FAST AND EASY TO INSTALL



M12 GALVANISED STEEL

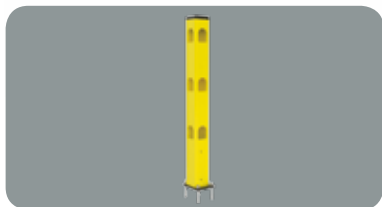

ANG PED 150 DX
Equipped with accessories

Packing Colour **to be defined**
Colour **M**

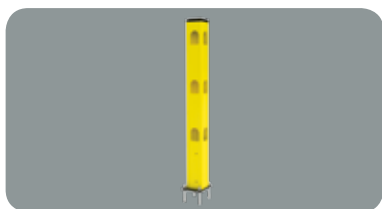
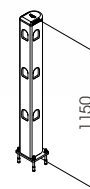

ANG PED 150 SX
Equipped with accessories

Packing Colour **to be defined**
Colour **M**

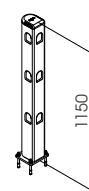

PEDESTRIAN 90 REINFORCED



FAST AND EASY TO INSTALL



M12 GALVANISED STEEL



PED 90 REF MODULAR
Equipped with accessories

Packing Colour **unpacked on pallet**
M

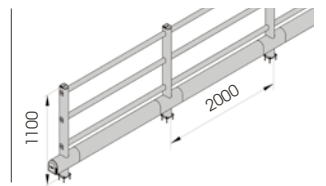

DOOR PEDESTRIAN 90

DIFFERENT
SIZES ON
REQUEST



DP 90 600
800
1000
Equipped with accessories

Packing Colour to be defined
M

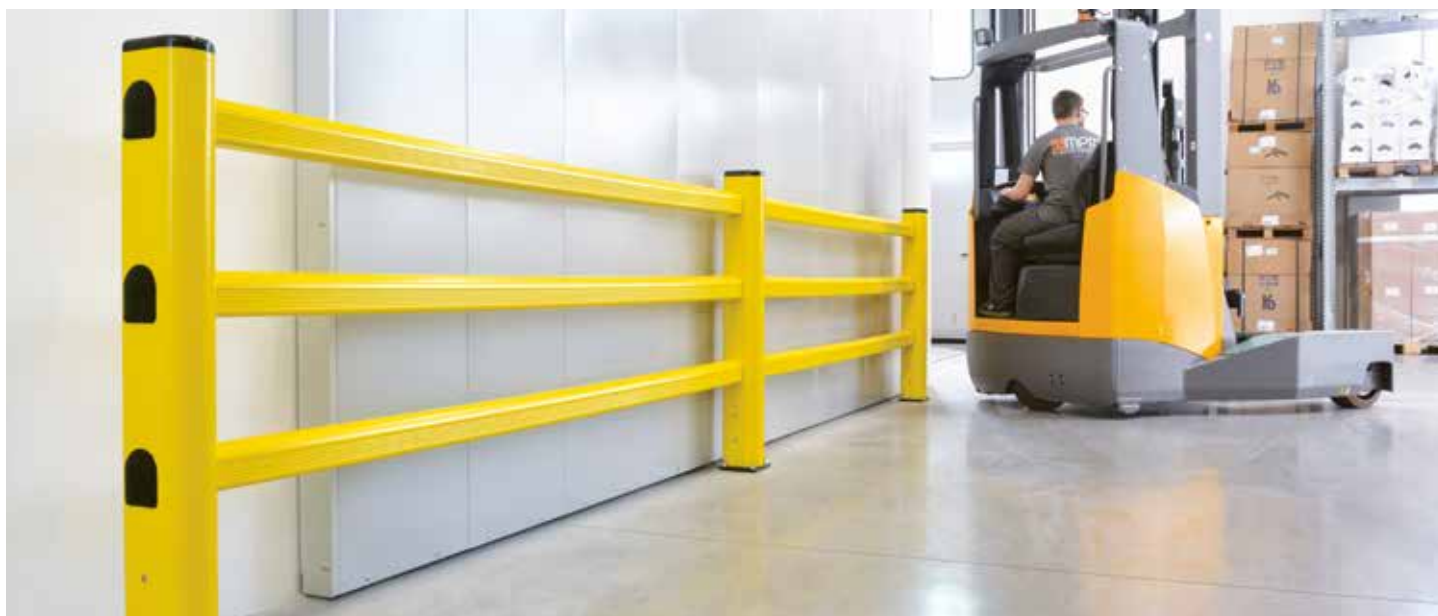
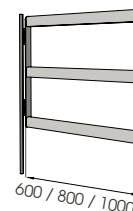

DOOR PEDESTRIAN 150

DIFFERENT
SIZES ON
REQUEST



DP 150 600
800
1000
Equipped with accessories

Packing Colour **to be defined**

M

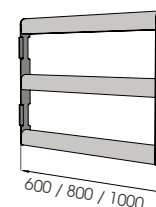

COLUMN PROTECTION 90



DIFFERENT SIZES ON REQUEST



**M16
STAINLESS STEEL**



**COPRO 90 500x500
600x600
700x700**
Equipped with accessories

Packing Colour **unpacked on pallet**
Colour **M**

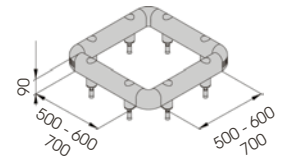

COLUMN PROTECTION 150



DIFFERENT SIZES ON REQUEST



M20 STAINLESS STEEL



COPRO 150 500x500
600x600
700x700
Equipped with accessories

Packing Colour **M** unpacked on pallet

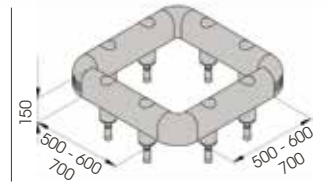

TOWER PROTECTION



DIFFERENT SIZES ON REQUEST



M12 GALVANISED STEEL



**TOWER 500x500
600x600
700x700**
Equipped with accessories

Packing to be defined
Colour **M**

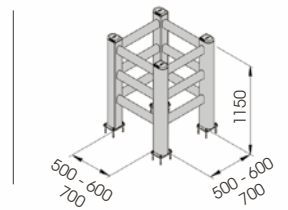

Guard Rail

FULL FRAME



DIFFERENT
SIZES ON
REQUEST

FAST
AND EASY
TO INSTALL



M12
GALVANISED STEEL



04

KERB

To install with Channels CH and CU
Monta con canale CH e CU
À installer avec les U de sol CH et CU



A large size protection system, ideal for walls and panels. Easy to install and clean. Fully equipped with corner caps and buttons.

Sistema di protezione di grandi dimensioni, ideale per muri e pannelli. Facile da installare e pulire. Completo di angolari e tappi.

Système de protection de grands dimensions, idéal pour les murs et les panneaux. Facile à installer et à nettoyer. Complété de bouchons d'angles et d'embouts.

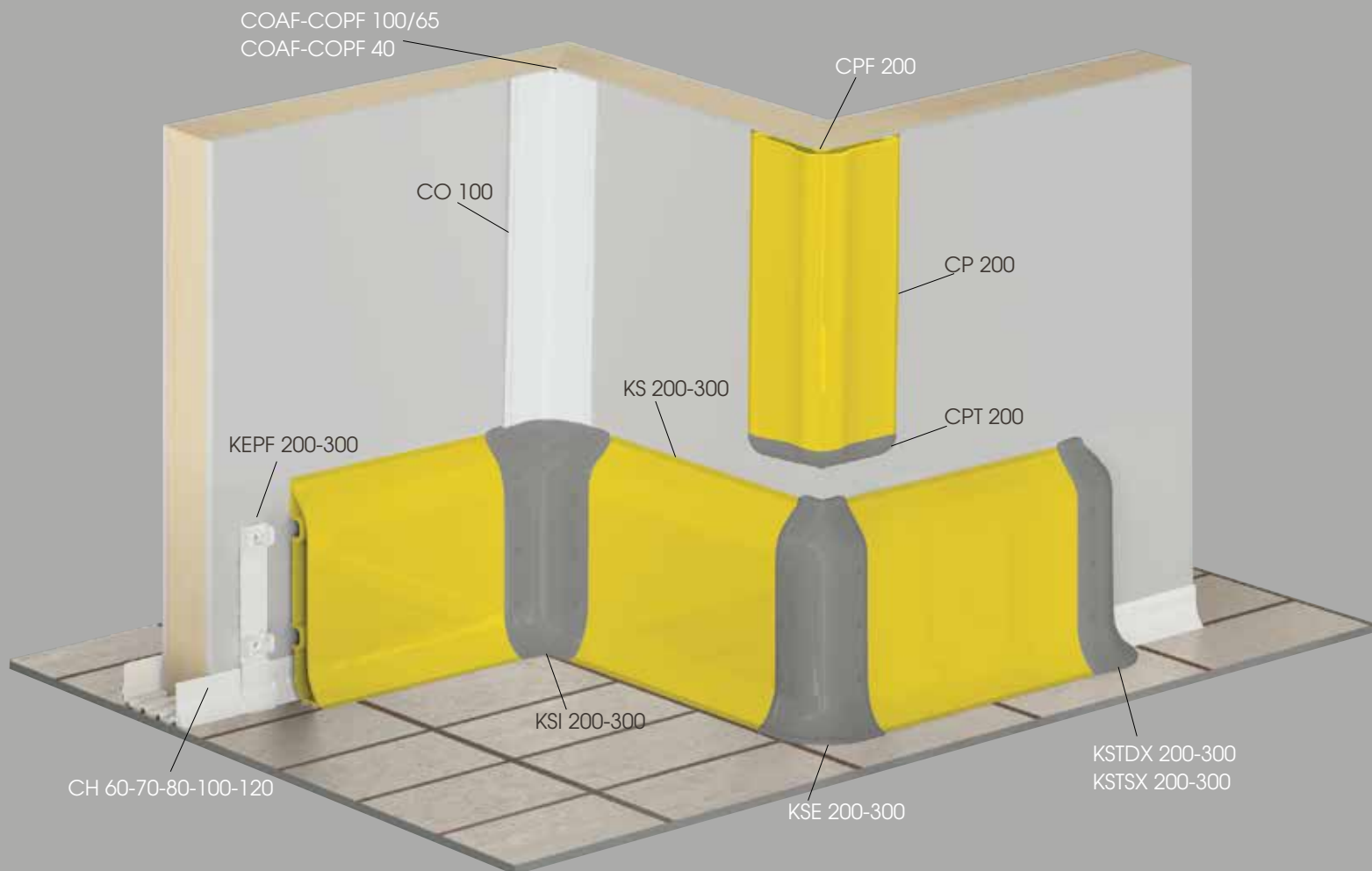

Kerb



KS 200

Length **4.000 mm**
 Packing **3 pz / box**
 Colour **B M E**

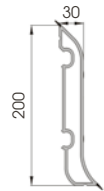

KEPF 200

To install with TB14

Packing **50 pz / box**
 Colour **K**

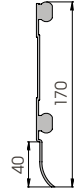

KSJ 200

To install with TB14 / TF14

Packing **20 pz / box**
 Colour **B E**

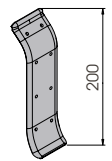

KSI 200

To install with TB14 / TF14

Packing **20 pz / box**
 Colour **B E**

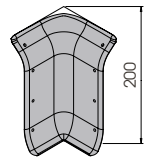

KSE 200

To install with TB14 / TF14

Packing **20 pz / box**
 Colour **B E**

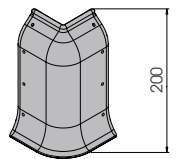

KSTD/SX 200

To install with TB14 / TF14

Packing **20 pz / box**
 Colour **B E**

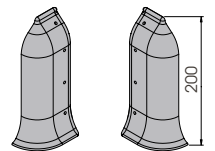

KSJ 200 LT



Packing **to be defined**
 Colour **K**

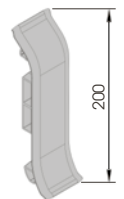

KS 300

Length **4.000 mm**
 Packing **1 pz**
 Colour **B M E**

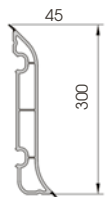

KEPF 300

To install with TB20

Packing **40 pz / box**

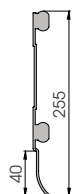



KSJ 300
To install with TB20 / TF20

Packing 10 pz / box
Colour B E

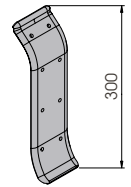

KSI 300
To install with TB20 / TF20

Packing 10 pz / box
Colour B E

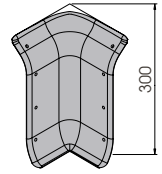

KSE 300
To install with TB20 / TF20

Packing 10 pz / box
Colour B E

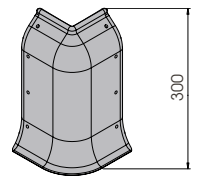

KSTD/SX 300
To install with TB20 / TF20

Packing 10 pz / box
Colour B E

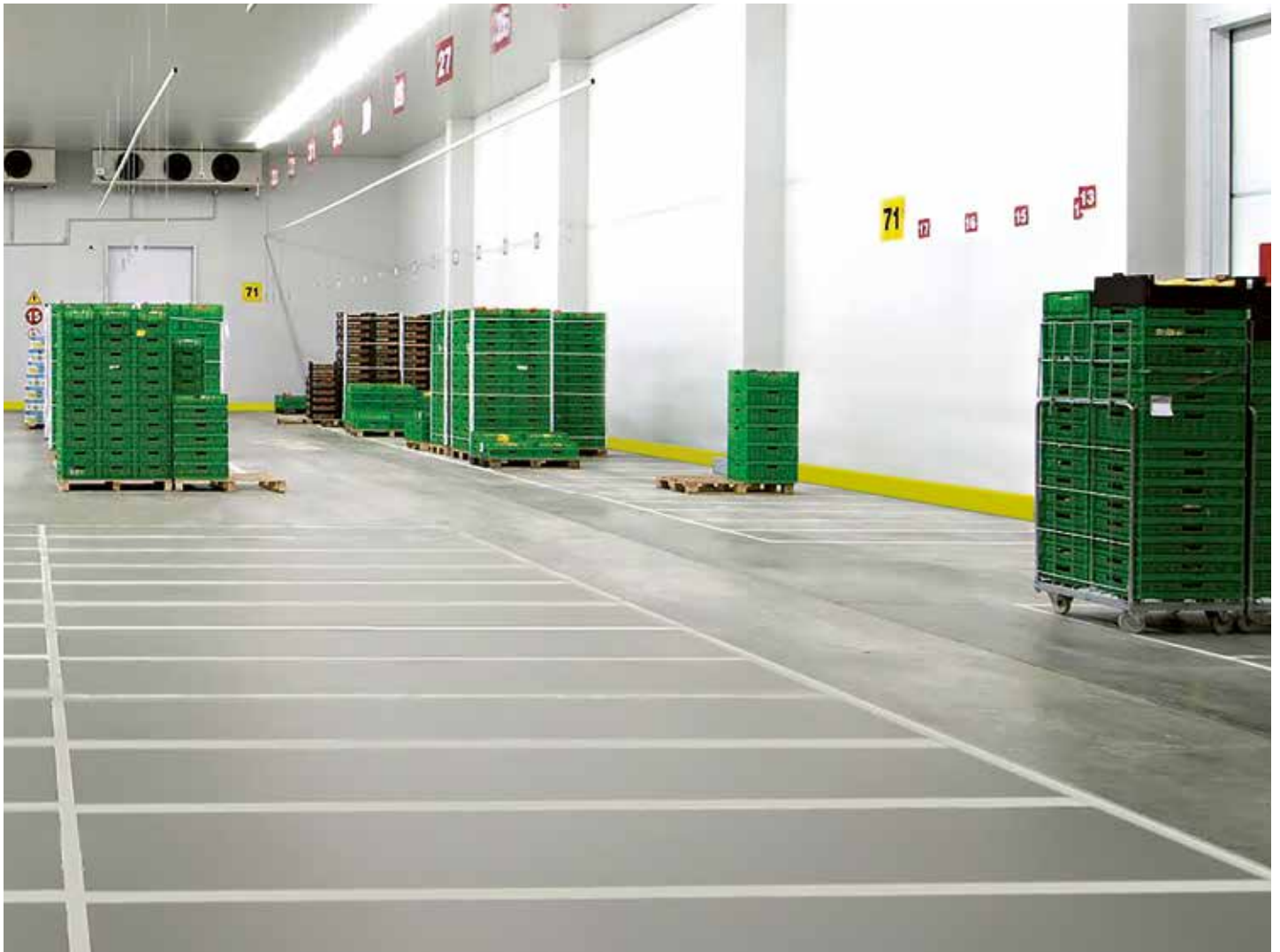
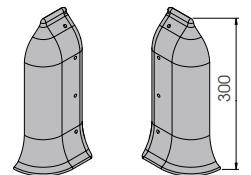

05

CORNER PROTECTION

Designed to protect pillars and columns
or external corners of walls and panels.

Realizzato per proteggere pilastri e colonne
o angoli esterni di muri e pannelli.

Etudié pour protéger les poteaux et les colonnes
ou les angles extérieurs de murs et de panneaux.



CP 100

Length **4.000 mm**
 Packing **10 pz / box**
 Colour **B M E F**

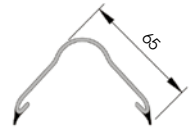

CPF 100

Length **4.000 mm**
 Packing **10 pz / bag**



CPT 100

Packing **40 pz / box**
 Colour **B E F**

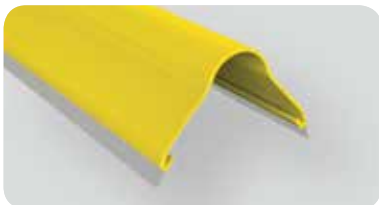
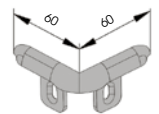

CP 200

Length **4.000 mm**
 Packing **2 pz / bag**
 Colour **B M E**
 Length **2.000 mm**
 Packing **2 pz / bag**
 Colour **M**



CPF 200

Length **2.000 / 4.000 mm**
 Packing **2 pz / bag**



CPT 200

Packing **20 pz box**
 Colour **B E**

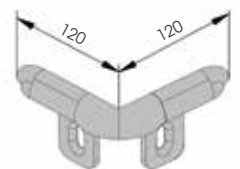

06

WALL PROTECTION



New bumper without guides. Thanks to its big size and resistance it is ideal for protection of industrial spaces. Fixed caps with hidden screws covered by specific buttons.

Nuovo profilo antiurto senza guida. La sua ampiezza e resistenza lo rende ideale per la protezione di ambienti industriali. Terminali fissati con viti nascoste da appositi bottoni.

Nouveau profilé anti-choc sans besoin d'une base à fixer. Sa mesure large et sa résistance en font le profilé parfait pour la protection des espaces industriels. Embouts fixés avec des vis cachées grâce à des bouchons spécifiques.



Wall Protection

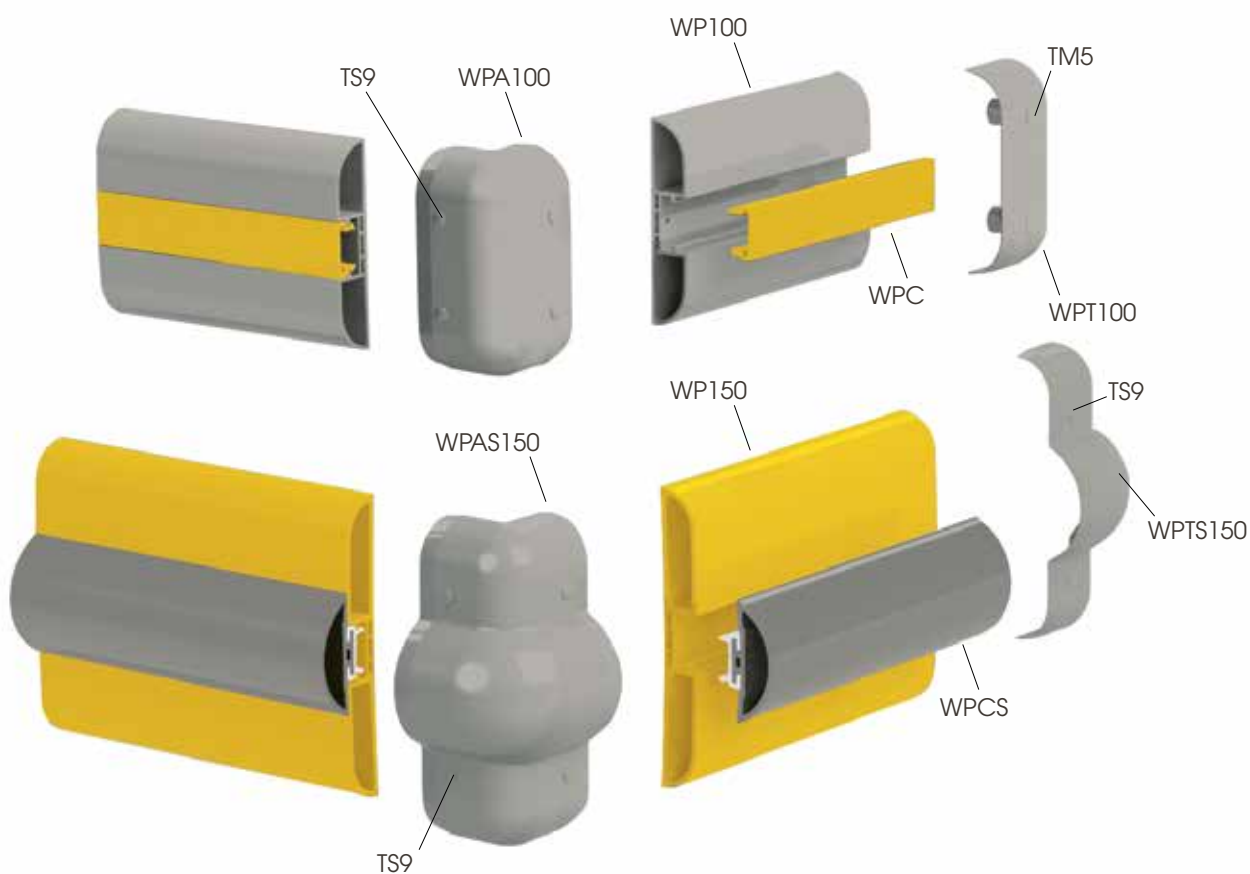

WP 100

Length **4.000 mm**
 Packing **8 pz / box**
 Colour **B E F**

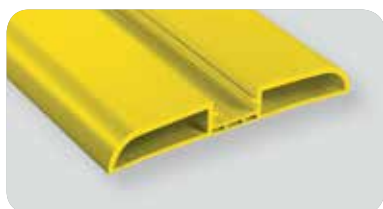
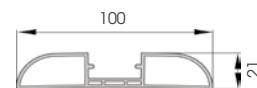

WP 150

Length **4.000 mm**
 Packing **4 pz / box**
 Colour **B M E**

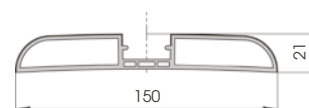

WPC

To install with WP 100 / WP 150

Length **4.000 mm**
 Packing **16 pz / box**
 Colour **A B M D E F G H**

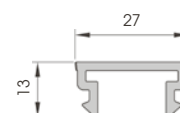



WPT 100
To install with TM5

Packing 50 pz / box
Colour B E F

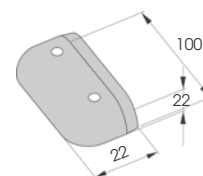

WPA 100
To install with TS9

Packing 20 pz / box
Colour B E

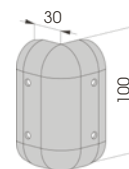

WPT 150
To install with TM5

Packing 50 pz / box
Colour B E

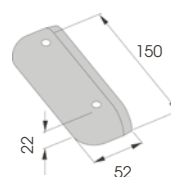

WPA 150
To install with TS9

Packing 20 pz / box
Colour B E

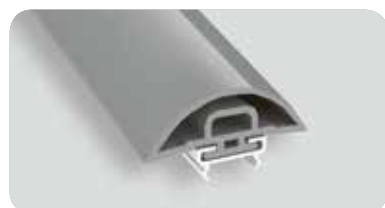
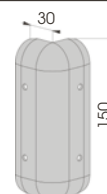

WPCS
To install with WP 100 / WP 150

Length 4.000 mm
Packing 8 pz / box
Colour A B M D E
F G H I



WPTS 100
To install with TS9

Packing 20 pz / box
Colour B E

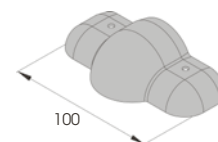

WPAS 100
To install with TS9

Packing 20 pz / box
Colour B E

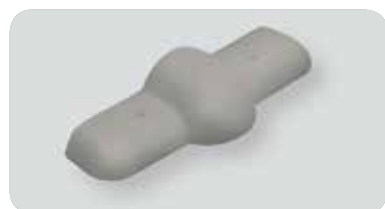
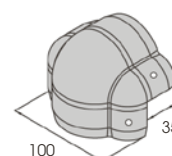

WPTS 150
To install with TS9

Packing 20 pz / box
Colour B E

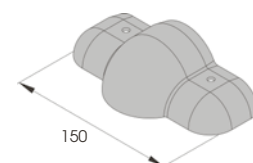

WPAS 150
To install with TS9

Packing 20 pz / box
Colour B E

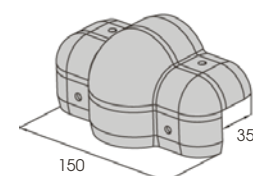

07

ANTISHOCK SYSTEM

New bumper and plinth system produced in soft material, could be used in cold rooms, refrigerated storages and garages. Thanks to material elasticity, it features good anti-shock property.

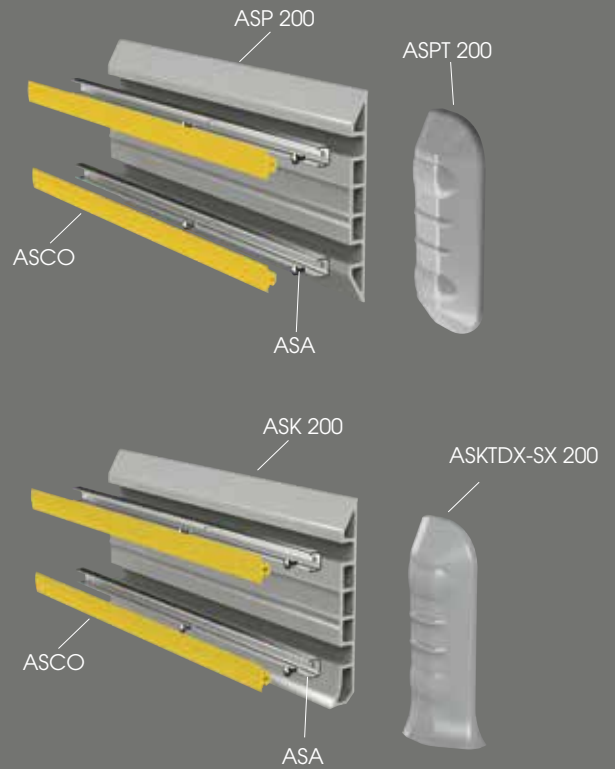

Nuova linea di paracolpi e battiscopa in materiale morbido per celle frigo, magazzini refrigerati, garage. Ottima proprietà anti-urto grazie all'elasticità del materiale utilizzato.

Nouvelle gamme de lisses de protection et plinthes en matière souple pour les chambres froides, depots et garages. Excellente propriété anti-choc grâce à l'élasticité du matériel utilisé.



ASK 200



Length **4.000 mm**
Packing **2 pz / box**
Colour **B C**

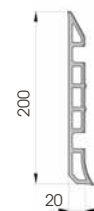

ASK2I200



Packing **to be defined**
Colour **B**



ASK2E 200



Packing **to be defined**
Colour **B**

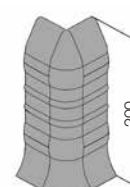

ASKTDX-SX 200



Packing **to be defined**
Colour **B**

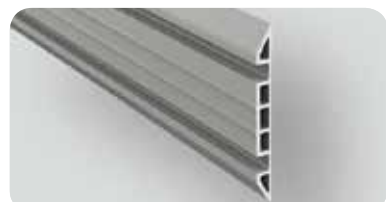

ASP 200



Length **4.000 mm**
Packing **2 pz / box**
Colour **B C**

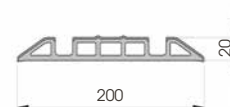

ASPT 200



Packing **10 pz / box**
Colour **B D**

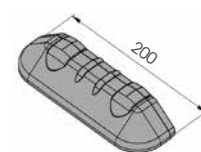

ASA

Material **aluminium**
Length **4.000 mm**
Packing **8 pz / bundle**

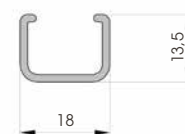

ASCO



Packing **2 pz / box**
L = 32.000 mm
Colour **A B C D G**

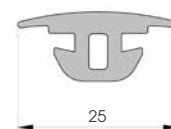

08

PVC PANEL



PVC sheets to renovate fastly and cheaply the walls of cold rooms and cold store.

Lastre in PVC per il rinnovo rapido ed economico delle pareti nelle celle e nei magazzini frigoriferi.

Plaques en PVC pour renover rapidement et a bas prix les murs de chambres froides et de depots frigorifiques.

DIFFERENT
SIZES ON
REQUEST



PF 300

Foamed inside

FOAMED
INSIDE

Length **3.000/4.000 mm**
Packing **3 pz / bag**
Colour **White**



PR 300

Length **3.000/4.000 mm**
Packing **3 pz / bag**
Colour **White**



PJ

To install with PR 300 and PF 300

Length **3.000 mm**
Packing **10 pz / box**
Colour **White**

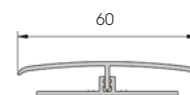

PA

To install with PR 300 and PF 300

Length **3.000 mm**
Packing **10 pz / box**
Colour **White**



PT

To install with PR 300 and PF 300

Length **3.000 mm**
Packing **10 pz / box**
Colour **White**

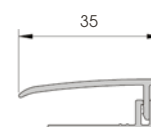



**FLEXIBLE
COMPACT
RECYCLABLE
LONG LIFE**

Now ready **new options** for our **SAFETY BARRIERS** and **RACK PROTECTORS**



REMOVABLE SAFETY BARRIERS

Available for SM / PED 90 / LM / PED 150



PEDESTRIAN 90 **4PE 90**

**NEW
ADDITIONAL
RAIL**



PEDESTRIAN 150 **4PE 150**



Now available
**CUSTOMISED
RACK PROTECTOR,**
new version
of rack protector
processed upon
request!

CUSTOMISED RACK PROTECTOR



CORNER PED 90

Fixing accessories



TM5
Hole required \varnothing 8.5
Neutral polyethylene. 100/500 Pcs. / bag.



TB20
Hole required \varnothing 5
Steel / aluminium. 500 Pcs. / box.



TS9
Hole required \varnothing 5
White or grey nylon. 1000 Pcs. / bag.



TF14
Hole required \varnothing 5.
Aluminium. 500 Pcs. / box.



TB14
Hole required \varnothing 4
Steel / aluminium, white. 500 Pcs. / box.



TF20
Hole required \varnothing 6.5.
Aluminium. 500 Pcs. / box.



FR CHEMICAL ANCHOR
300 ML

Colours

A	B	C	D	E	F	G	H	I	K	L	M
RED RAL 3002	GREY RAL 7040	YELLOW RAL 1023	BLACK RAL 9005	WHITE RAL 9010	WHITE RAL 9002	BLUE RAL 5005	GREEN RAL 6029	SILVER RAL 9006	LIGHT GREY RAL 7035	DARK GREY RAL 7024	LIGHT YELLOW RAL 1018

	Cleaner resistant		Good waterproof	<input type="checkbox"/>	<input type="checkbox"/>
	Quick assembly		Easy to clean	YES	NO
	Shockproof		Good thermal insulation		
	Cheap		Non toxic		
	Long resistance		Class V0 self-extinguishing fire resistance		

MPM srl reserves the right, at any time, to introduce the necessary changes and improvements to its products. Any small imperfection in the products and in the materials used are due to the processing method. Any reproduction of this brochure, even in part, is forbidden.

THE WORLD'S TOP **LOGISTICS**
PROFESSIONALS CHOOSE OUR
QUALITY MADE IN ITALY



SOME OF OUR REFERENCES



PORSCHE



PHILIP MORRIS



ALESSI



MAINA



MPM states that:

Resistance refers to tests performed on the sample. The safety coefficient and consequent use of the product requires preliminary screening by a designer who will necessarily have to take account of the actual installation conditions. In any case, it is necessary to comply with the appropriate mounting regulations. The data refers to an intact product that can be affected by alterations from incorrect maintenance and old age, as well as the methods and characteristics of installation (with specific reference to floor-mounted products like the latter).

The weight, dimensions, colours and characteristics of the material refer to the sample and the conformity with the latter of the product supplied will be subject to normal production tolerance. The product may be affected by environmental installation conditions.

For safety purposes, installation requires screening by a qualified person as required by law. Instructions contained in catalogues, orders, transport documents or any other documentation showing the product characteristics, should not be considered suitable to compensate for any lack of design or technical testing required for installation of the product.

Images in the brochure are for advertising purposes only and do not in any way represent how the products should be used.

Impact forces indicated in the brochure, or in other documents, refer to laboratory tests and cannot take account for consequences determined by installation modes or peculiarities of the place where the products are installed.

The profiles provided by MPM are suitable for assembling the panels but this must be preceded by a project drawn up by a person holding the technical qualifications as required by and in compliance with the law; MPM declines any responsibility for the use of profiles in situations that have not been preceded by the checks now indicated.

The drawing in the brochure, or in other documentation provided by MPM, portrays a potential use of the product but cannot substitute the project and the technical checks by a qualified technician as required by law.

With specific reference to the T Suspension product, MPM declares that the product is suitable for assembling the surface (ceiling, floor, etc.) but its use must be preceded by adequate planning with specific evaluation of the weight of the panel and its intended use (and specifically the weight that said surface will have to bear in relation to the different uses).



NEW WAREHOUSE

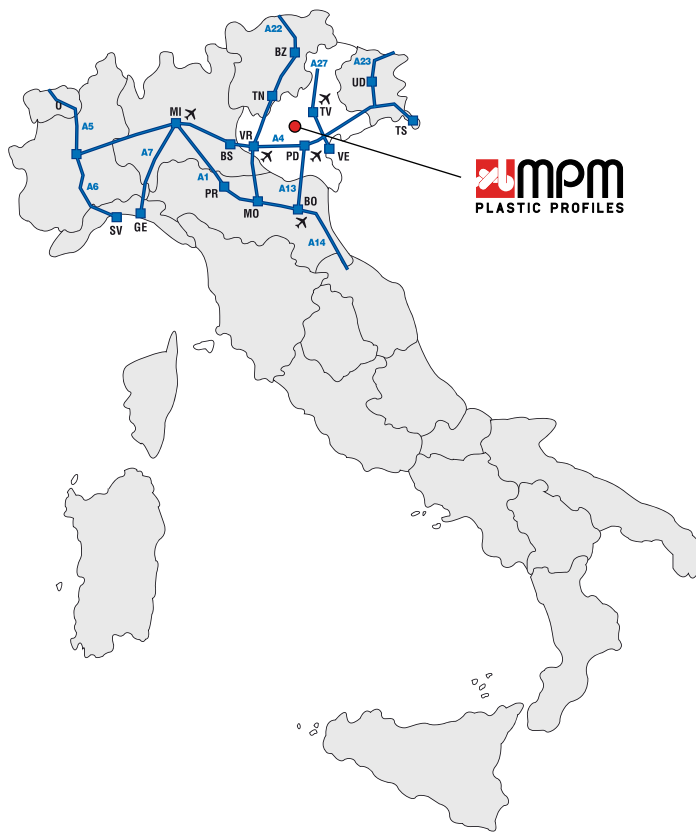

M.P.M. s.r.l.
Via Europa 2
35010 Fratte
di S. Giustina in Colle
Padova · Italy

T +39 049 9301773
F +39 049 9300427
info@mpmpvc.com
mpmpvc.com